



# B531 Series Regulator

## Twin Parallel Commercial Regulators

Use the B531<sup>®</sup> for light utility, industrial and commercial application. The twin parallel design should be used where a high degree of safety and overpressure protection are required such as schools, hospitals and community centers. This regulator is an excellent replacement for parallel regulator piping systems.

### MODEL DESCRIPTIONS

#### » B531N

The B531N is a spring loaded self operated regulator with no internal relief. This regulator can be used on low or intermediate inlet pressures where an internal relief valve is not required.

#### » B531R

The B531R is the internal relief version of the B531R Series. This model features twin 1" internal relief valves. Due to its excellent relief characteristics, the B531R can be used on any inlet system up to the regulator's maximum operating pressure rating.

#### » B531IMN (See page 12 Schematic)

The B531 IMN is equipped with an internal monitor (IM) orifice that operates upon failure of the main valve. The "N" designation signifies no internal relief valve.

#### » B531IMR (See page 12 Schematic)

The B531IMR is equipped with an internal monitor (IM) orifice as a primary form of overpressure protection that operates upon failure of the main valve seat. The B531IMR is also equipped with

secondary twin internal relief valves open in the event that both the main seat and the internal monitor cannot function.

#### » B531IMRV (See page 12 Schematic)

The B531IMRV is equipped with an internal monitor (IM) orifice as a primary form of overpressure protection that operates upon failure of the main valve. It is also equipped with the vent-hole "V" option which gives a warning indication that the regulator is on monitor control in the event of main valve failure. The vent-hole "V" option consists of a 1/16" hole in the sliding orifice that allows a small amount of gas to bleed downstream which causes the relief valves to weep gas. In the unlikely event the main valve and the monitor valve fails to function, the B531IMRV is equipped with secondary or back-up twin internal relief valves.

### Option Designations

N	No internal relief
R	Internal relief
IMN	Internal monitor without internal relief
IMR	Internal monitor with internal relief
IMRV	Internal monitor with internal relief and vent

### FEATURES

- » Interchangeable brass orifice
- » Combined 54 in2 of diaphragm area
- » Twin Spring-loaded internal relief valve assemblies
- » Field interchangeable adjustment springs
- » No special adjustment tools required
- » Controlled size breather orifice eliminates pulsation and provides normal actuation at low flows
- » Wide range of valve body sizes

### BENEFITS

- » Eliminates parallel regulator piping installations
- » Light weight
- » Fast response protects equipment from shock damage
- » Field inspection of the internal monitor and internal relief valves without customer shut-off or by-pass
- » Unmatched overpressure protection with internal monitor plus internal relief options

**SHIPPING WEIGHT**

Two regulators per box

Box weight: 45 lbs.

**B531 DIMENSIONS AND ASSEMBLY POSITIONS**

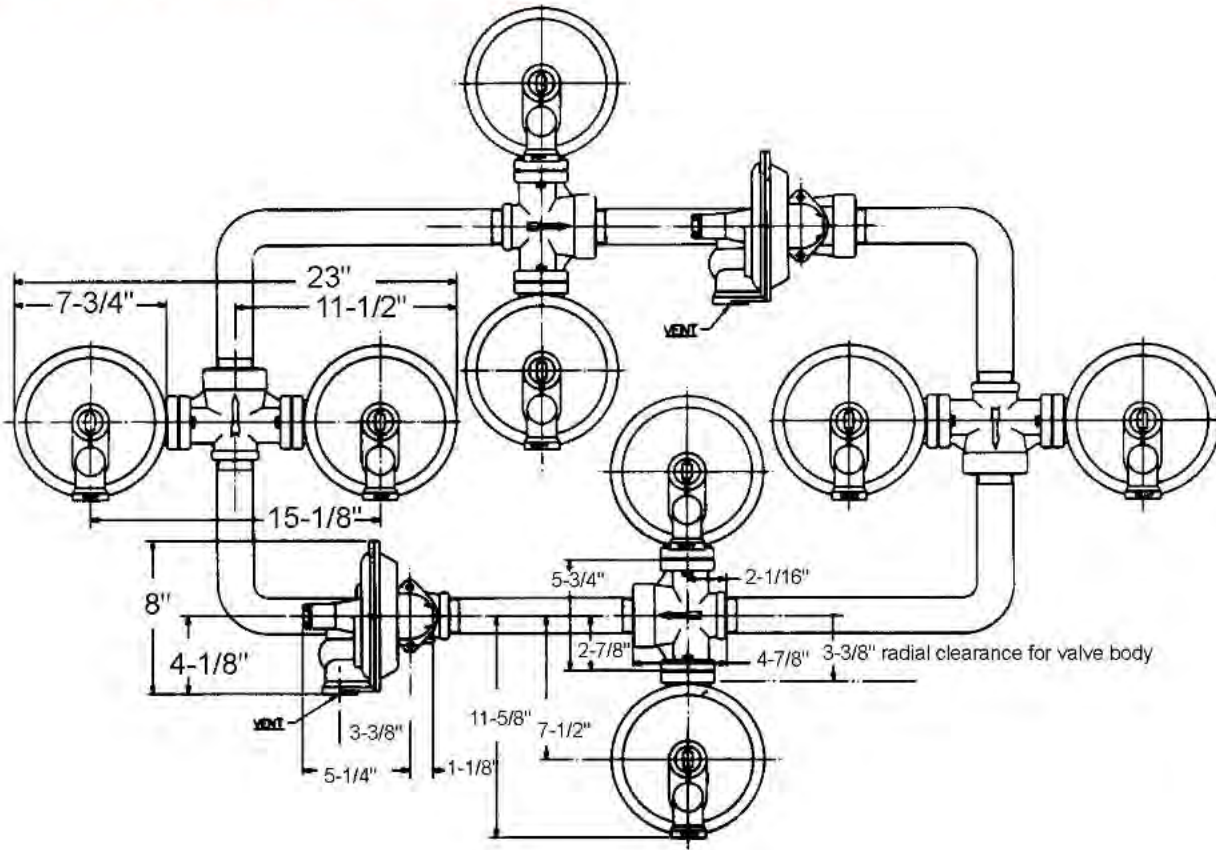

**OPERATIONAL SCHEMATIC**

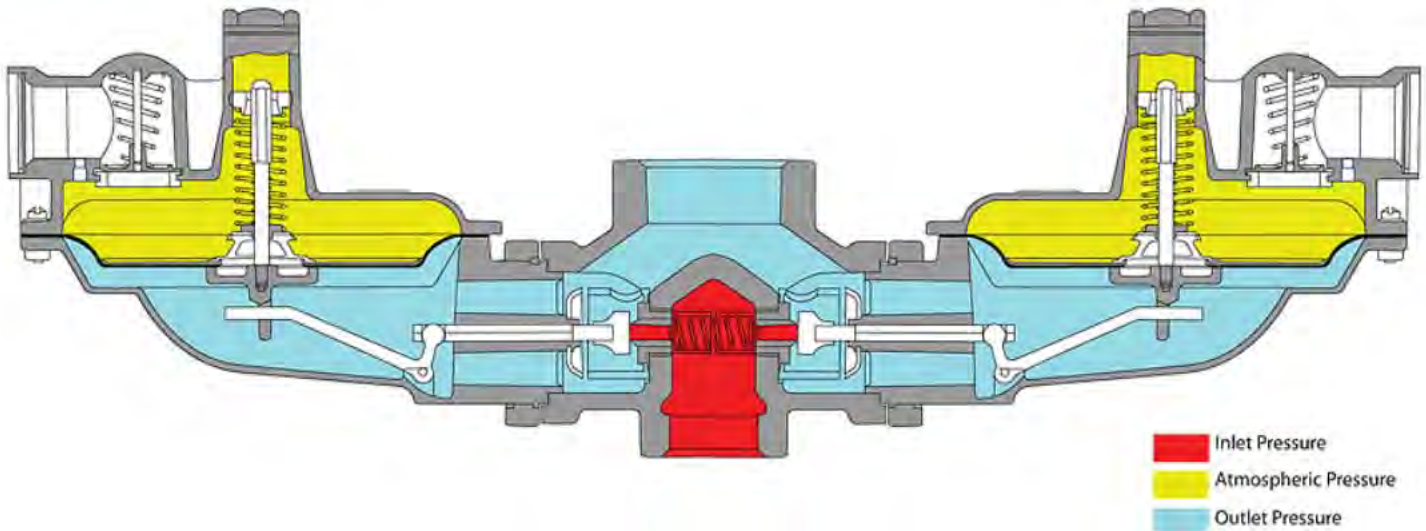

**B531 SPRING DATA, SPRING COLOR OUTLET PRESSURE RANGE\***

<b>Models N, R</b>	<b>Inches w.c.</b>	<b>Basic Setting (inches w.c.)</b>
Brown	4.5 - 5.25	5
Dark green	5.0 - 6.75	6
Light green	5.5 - 7.5	7
Black	7.0 - 10.0	9
Blue	8.0 - 11.0	11
Silver	11.0 - 15.0	14
	<b>PSIG</b>	<b>Basic Setting (PSIG)</b>
Red/gray	0.75 - 1.1	1.00
Red/blue	1.1 - 1.5	1.25
Yellow	1.3 - 2.0	1.50
White	1.75 - 2.5	2.00
<b>Models IMN, IMR</b>	<b>Inches w.c.</b>	<b>Basic Setting (inches w.c.)</b>
Brown	4.5 - 5.0	5
Dark green	5.5 - 6.0	6
Light green	6.0 - 7.0	7
Black	7.0 - 9.0	9
Blue	8.0 - 10.0	10
Silver	9.0 - 13.0	11
	<b>PSIG</b>	<b>Basic Setting (PSIG)</b>
White/red	0.45 - 1.0	1.00
Yellow	1.1 - 1.5	1.25
Red	1.25 - 1.75	1.50
White	1.5 - 2.25	2.00

\*Spring ranges are approximate and may vary by application.

**ORIFICE DATA: WIDE OPEN FLOW COEFFICIENTS AND MAXIMUM PRESSURE DATA**

Orifice Size (inches)	K-Factor (SCFH/PSI)	Maximum Operating Inlet Pressure	Maximum Emergency Inlet Pressure All models	Maximum Emergency Outlet Pressure PSIG
		Inches w.c. Delivery Pressure PSIG (bar)	All outlet pressures PSIG (bar)	
1/8	60	125 (8.6)	300 (20.6)	60
1/8 IM	70	125 (8.6)	300 (20.6)	
3/16	140	125 (8.6)	300 (20.6)	
3/16 IM	135	125 (8.6)	300 (20.6)	
1/4	155	125 (8.6)	300 (20.6)	
1/4 IM	130	60 (4.1)	300 (20.6)	
5/16"	187	75 (5.1)	150 (10.3)	
5/16 IM	180	60 (4.1)	150 (10.3)	
3/8	580	60 (4.1)	150 (10.3)	
1/2	1000	30 (2.1)	100 (6.9)	

**OPERATING TEMPERATURE RANGE**

- 20°F to 150°F
- Silicone valve seats available below -20°F

**ADDITIONAL SPECIFICATIONS**

Available vent sizes	3/4", 1" NPT
Other available options	Seal wire to indicate tampering
Pressure taps	1/8" pipe plug tap on inlet side of valve body
Loading ring position	0° (directly downstream)
	Tamper proof (Torx head) diaphragm case screws

## CONSTRUCTION

Itron takes pride in delivering American made products with the utmost concern for safety, quality, and customer satisfaction.

### Construction material

Valve body	High tensile strength cast iron (ASTM A-126 Class A)
Orifice	Brass (ASTM B16 Alloy 360) for IMR, IMN, IMRV, and RAS orifices; aluminum, N and R
Valve seat	Buna-N or silicone (optional) for temperatures below -20°F
Valve stem	Anodized aluminum
Lever	Zinc and dichromate plated steel (AISI C1010)
Lever pin	Stainless steel (Type 303)
Upper diaphragm plate	Zinc and dichromate plated steel (14 gauge steel)
Lower diaphragm plate	Die cast aluminum (ASTM B-85 Alloy SC84A)
Diaphragm	Buna-N and nylon reinforcing fabric
Vent valve/seat	Neoprene
Vent screen	Stainless steel (16 mesh)
Adjustment ferrule	Cast aluminum (ASTM CS43A)
Seal cap	Die cast aluminum (ASTM CS43A)
Diaphragm case	Die cast aluminum (ASTM B85 - Alloy SC84A)

### VALVE BODY SIZES\*

Inlet (inches)	Outlet (inches)
3/4	3/4
3/4	1-1/4
1	1-1/2
1	2
1-1/4	1-1/4
1-1/4	1-1/2
1-1/4	2

\*All sizes available with 1/8" NPT inlet tap.

## CORRECTION FACTORS FOR NON-NATURAL GAS APPLICATIONS

The B531 may be used to control gases other than natural gas. To determine the capacity for gases other than natural gas, multiply the values within the capacity tables by a correction factor. The table below lists the correction factors for some of the more common gases:

Gas Type	Specific Gravity	Correction Factor (CF)
Air	1.00	0.77
Butane	2.01	0.55
Carbon Dioxide (Dry)	1.52	0.63
Carbon Monoxide (Dry)	0.97	0.79
Natural Gas	0.60	1.00
Nitrogen	0.97	0.79
Propane	1.53	0.63
Propane-Air-Mix	1.20	0.71

To calculate the correction factor for gases not listed in the table above, use the gases' specific gravity and insert it in the formula listed below:

$$\text{Correction Factor (CF)} = \sqrt{\frac{SG_1}{SG_2}}$$

Where:

$SG_1$  = Specific gravity of the gas in which the capacity is published.

$SG_2$  = Specific gravity of the gas to be controlled.

## Wide Open Flow Calculations

For wide-open orifice flow calculations use the following equations:

$$\text{For } \frac{P_1}{P_2} < 1.89 \quad \text{use: } Q = K\sqrt{P_2(P_1 - P_2)}$$

$$\text{For } \frac{P_1}{P_2} > 1.89 \quad \text{use: } Q = \frac{KP_1}{2}$$

Where:  $P_1$  = Absolute Inlet Pressure (PSIA)

$P_2$  = Absolute Outlet Pressure (PSIA)

$Q$  = Flow Rate (SCFH)

$K$  = Orifice Coefficient (SCFH/PSI)

**B531 COMMERCIAL AND INDUSTRIAL REGULATOR, MODELS N AND R**

**Set Point 7" w.c. (17.5 mbar) @ 200 SCFH (5.68 m<sup>3</sup>/hr) Capacity Table (1" Droop), Valve Body 1-1/4" x 1-1/2"**

Capacities in SCFH of 0.6 S.G. gas; base conditions of 14.7 PSIA and 60°F.

Typical Capacity Info.	
Manufacturer	Itron
Type and model	B531
Regulator	
Inlet size	1-1/4"
Outlet size	1-1/2"
Spring color	Green
	Black
Position	5

Inlet Pressure		Orifice Size					
		1/8"	3/16"	1/4"	5/16"	3/8"	1/2"
PSIG	Bar						
8" w.c.	0.02						325 (9.1)
10" w.c.	0.02				280 (7.8)	340 (9.5)	420 (11.8)
12" w.c.	0.03			290 (8.1)	350 (9.8)	400 (11.2)	480 (13.4)
14" w.c.	0.03		230 (6.4)	310 (8.7)	390 (10.9)	430 (12.0)	540 (15.1)
16" w.c.	0.04		250 (7.0)	340 (9.5)	420 (11.8)	470 (13.2)	650 (18.2)
18" w.c.	0.04		290 (8.1)	360 (10.1)	450 (12.6)	500 (14.0)	720 (20.2)
21" w.c.	0.05		310 (8.7)	400 (11.2)	460 (12.9)	540 (15.1)	760 (21.3)
24" w.c.	0.06		340 (9.5)	450 (12.6)	500 (14.0)	590 (16.5)	840 (23.5)
1	0.07	285 (8.0)	360 (10.1)	490 (13.7)	570 (16.0)	650 (18.2)	920 (25.8)
2	0.13	300 (8.4)	520 (14.6)	660 (18.5)	800 (22.4)	950 (26.6)	1250 (35.0)
3	0.20	365 (10.2)	610 (17.1)	800 (22.4)	1100 (30.8)	1150 (32.2)	1500 (42.0)
5	0.33	490 (13.7)	800 (22.4)	1050 (29.4)	1450 (40.6)	1700 (47.6)	2000 (56.0)
10	0.67	660 (18.5)	1220 (34.2)	1550 (43.4)	1850 (51.8)	2200 (61.6)	2650 (74.2)
20	1.33	1050 (29.4)	1850 (51.8)	2300 (64.4)	2650 (74.2)	2900 (81.2)	3150 (88.2)
30	2.00	1400 (39.2)	2400 (67.2)	2850 (79.8)	3000 (84.0)	2900 (81.2)	3400 (95.2)
40	2.67	1700 (47.6)	2900 (81.2)	3200 (89.6)	3000 (84.0)	2900 (81.2)	
50	3.33	2050 (57.4)	3250 (91.0)	3500 (98.0)	3000 (84.0)	3000 (84.0)	
60	4.00	2300 (64.4)	3300 (92.4)	3200 (89.6)	3100 (86.8)	3000 (84.0)	
70	5.00	2675 (74.9)	3478 (97.4)	2996 (83.9)	3317 (92.9)		
80	5.33	2940 (82.3)	3503 (98.1)	3277 (91.8)			
90	6.00	3070 (86.0)	3599 (100.8)	3422 (95.8)			
100	6.67	3050 (85.4)	3650 (102.2)	3800 (106.4)			
125	8.33	3200 (89.6)	3700 (103.6)	4000 (112.0)			

Lock-up Pressure (Inches w.c.) <sup>A</sup>	0.5	0.6	0.7	0.8	0.9	1.0
Inlet Effect (PSIG) <sup>B</sup>	100	90	60	45	30	20

Notes:

- A. Outlet pressure increase required for lock up in inches w.c.
- B. Change in inlet pressure (in PSIG) required to change outlet pressure in 1" w.c.

Capacities above the dark line were achieved using a black spring.

Capacities below the dark line were achieved using a light green spring.

 Inlet pressure is too low to achieve desired outlet pressure.

 Do not operate orifice in shaded inlet pressure.

**B531 COMMERCIAL AND INDUSTRIAL REGULATOR, MODELS N AND R**

**Set Point 7" w.c. (17.5 mbar) @ 200 SCFH (5.68 m<sup>3</sup>/hr) Capacity Table (1" Droop), Valve Body 1-1/4" x 2"**

Capacities in SCFH (m<sup>3</sup>/hr) of 0.6 S.G. gas; base conditions of 14.7 PSIA and 60°F.

Inlet Pressure		Orifice Size					
(PSIG)	Bar	1/8"	3/16"	1/4"	5/16"	3/8"	1/2"
8" w.c.	0.02						325 (9.1)
10" w.c.	0.02				280 (7.8)	340 (9.5)	420 (11.8)
12" w.c.	0.03			290 (8.1)	350 (9.8)	400 (11.2)	480 (13.4)
14" w.c.	0.03		230 (6.4)	310 (8.7)	390 (10.9)	430 (12.0)	540 (15.1)
16" w.c.	0.04		250 (7.0)	340 (9.5)	420 (11.8)	470 (13.2)	650 (18.2)
18" w.c.	0.04		290 (8.1)	360 (10.1)	450 (12.6)	500 (14.0)	720 (20.2)
21" w.c.	0.05		310 (8.7)	400 (11.2)	460 (12.9)	540 (15.1)	760 (21.3)
24" w.c.	0.06		340 (9.5)	450 (12.6)	500 (14.0)	720 (20.2)	960 (26.9)
1	0.07	285 (8.0)	420 (11.8)	605 (16.9)	750 (21.0)	900 (25.2)	1400 (39.2)
2	0.13	300 (8.4)	575 (16.1)	830 (23.2)	1150 (32.2)	1450 (40.6)	2040 (57.1)
3	0.20	370 (10.4)	720 (20.2)	1070 (30.0)	1420 (39.8)	1700 (47.6)	2440 (68.3)
5	0.33	490 (13.7)	950 (26.6)	1460 (40.9)	1880 (52.6)	2280 (63.8)	3150 (88.2)
10	0.67	720 (20.2)	1480 (41.4)	2220 (62.2)	2920 (81.8)	3350 (93.8)	4000 (112.0)
20	1.33	1050 (29.4)	2300 (64.4)	2950 (82.6)	4200 (117.6)	4320 (121.0)	4850 (135.8)
30	2.00	1390 (38.9)	3120 (87.4)	4200 (117.6)	4780 (133.8)	4850 (135.8)	5300 (148.4)
40	2.67	1700 (47.6)	3750 (105.0)	5000 (140.0)	5200 (145.6)	5250 (147.0)	
50	3.33	2000 (56.0)	4600 (128.8)	5000 (140.0)	5300 (148.4)	5400 (151.2)	
60	4.00	2250 (63.0)	5000 (140.0)	5000 (140.0)	5900 (165.2)	5900 (165.2)	
70	4.67	2570 (72.0)	5000 (140.0)	5000 (140.0)	5900 (165.2)		
80	4.84	2975 (83.3)	5000 (140.0)	5000 (140.0)	5900 (165.2)		
90	6.00	3100 (86.8)	5000 (140.0)	5000 (140.0)			
100	6.67	3200 (89.6)	5000 (140.0)	5000 (140.0)			
125	8.33	3200 (89.6)	5000 (140.0)	5000 (140.0)			

Lock Up Pressure (inches w.c.) <sup>A</sup>	0.5	0.6	0.7	0.8	0.9	1.0
Inlet Effect (PSIG) <sup>B</sup>	100	90	60	45	30	20

Notes:

- A. Outlet pressure increase required for lock up in inches w.c.
- B. Change in inlet pressure (in PSIG) required to change outlet pressure by 1" w.c.

Inlet pressure is too low to achieve desired outlet pressure.

Do not operate orifice in shaded inlet pressure area.



## B531 PERFORMANCE CURVES

### 7" w.c. Set Point

Type and model B531R

Inlet size 1-1/4"

Outlet size 2"

Orifice size 1/4"

Spring Color Black

Set point 7.0" w.c. with 40 PSIG inlet @ 200 SCFH. All test results are reported at a base of 14.7 PSIA at 60° F and with 0.6 S.G. gas.

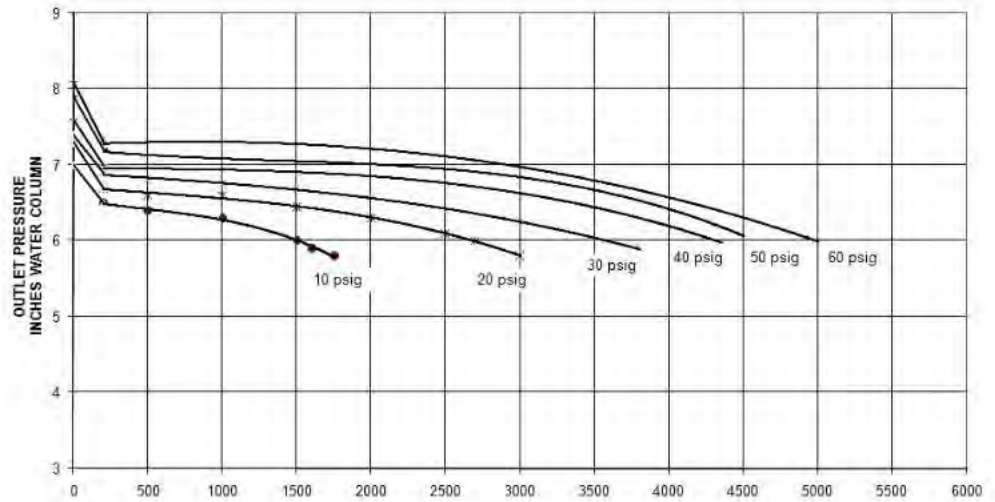

## B531 RELIEF CURVES R MODEL ONLY

### 7" w.c. Set Point

Type and model B531R

Inlet size 1-1/4"

Outlet size 2"

Vent size 1"

Set point 7.0" w.c. with 40 PSIG inlet @ 200 scfh. All test results are reported at a base of 14.7 PSIG at 60° F and with 0.6 S.G. gas.

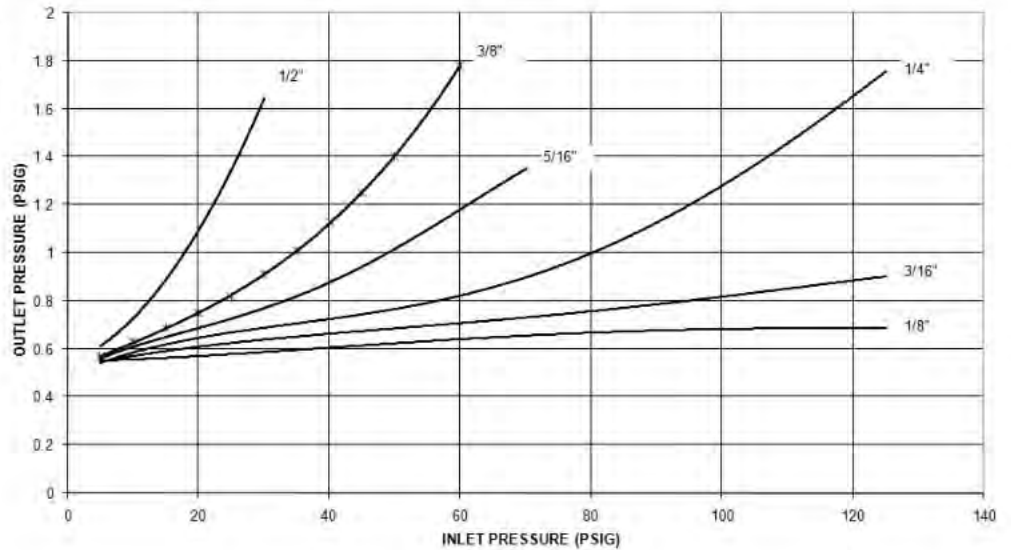

**B531 COMMERCIAL AND INDUSTRIAL REGULATOR, MODELS N AND R**

**Set Point 14" w.c. (35 mbar) @ 200 SCFH (5.68 m<sup>3</sup>/hr) Capacity Table (2" Droop), Valve Body 1-1/4" x 1-1/2"**

Capacities in SCFH (m<sup>3</sup>/hr) of 0.6 S.G. gas; base conditions of 14.7 PSIA and 60°F.

**Typical Capacity Info.**

Manufacturer	Itron
Type and model	B531R
Regulator	
Inlet size	1-1/4"
Outlet size	1-1/2"
Spring color	Silver
Position	5

Inlet Pressure		Orifice Size						
PSIG	Bar	1/8"	3/16"	1/4"	5/16"	3/8"	1/2"	
1	0.07		410 (11.5)	620 (17.4)	800 (22.4)	950 (26.6)	1400 (39.2)	
2	0.14	300 (8.4)	610 (17.1)	920 (25.8)	1150 (32.2)	1400 (39.2)	1800 (50.4)	
3	0.21	385 (10.8)	760 (21.3)	1160 (32.5)	1500 (42.0)	1620 (45.4)	2200 (61.6)	
5	0.34	510 (14.3)	1030 (28.8)	1480 (41.4)	1860 (52.1)	2150 (60.2)	2600 (72.8)	
10	0.69	715 (20.0)	1540 (43.1)	2240 (62.7)	2650 (74.2)	2950 (82.6)	3200 (89.6)	
20	1.38	1090 (30.5)	2300 (64.4)	3120 (87.4)	3500 (98.0)	3700 (103.6)	3900 (109.2)	
30	2.07	1380 (38.6)	2920 (81.8)	3600 (100.8)	3500 (98.0)	3700 (103.6)	4200 (117.6)	
40	2.76	1720 (48.2)	3400 (95.2)	3400 (95.2)	3700 (103.6)	4100 (114.8)		
50	3.45	2000 (56.0)	3700 (103.6)	3800 (106.4)	3900 (109.2)	4100 (114.8)		
60	4.14	2320 (65.0)	3950 (110.6)	3800 (106.4)	4000 (112.0)	4200 (117.6)		
75	5.17	2675 (74.9)	3745 (104.9)	3950 (110.6)	4387 (122.8)			
80	5.52	2995 (83.9)	3955 (110.7)	4060 (113.7)				
90	6.21	3200 (89.6)	4130 (115.6)	4250 (119.0)				
100	6.90	3300 (92.4)	4200 (117.6)	4300 (120.4)				
125	8.62	3500 (98.0)	4400 (123.2)	4400 (123.2)				

Lock-up Pressure <sup>A</sup>	14.5	14.5	14.7	15.3	15.5	16.0
-------------------------------	------	------	------	------	------	------

Notes:

A. Outlet pressure increase required for lock up in inches w.c.

Inlet pressure is too low to achieve desired outlet pressure.

Do not operate orifice in shaded inlet pressure area.

**B531 COMMERCIAL AND INDUSTRIAL REGULATOR, MODELS N AND R**

Set Point 14" w.c. (35 mbar) @ 200 SCFH (5.68 m<sup>3</sup>/hr) Capacity Table (2" Droop), Valve Body 1-1/4" x 1-1/2"

Capacities in SCFH (m<sup>3</sup>/hr) of 0.6 S.G. gas, base conditions of 14.7 PSIA and 60°F.

**Typical Capacity Info.**

Manufacturer	Itron
Type and model	B531R
Regulator	
Inlet size	1-1/4"
Outlet size	2"
Spring color	Black
Position	5

Inlet Pressure		Orifice size							
PSIG	Bar	1/8"	3/16"	1/4"	5/16"	3/8"	1/2"		
1	0.07		410 (11.5)	620 (17.4)	800 (22.4)	950 (26.6)	1400 (39.2)		
2	0.14	300 (8.4)	610 (17.1)	920 (25.8)	1150 (32.2)	1400 (39.2)	1800 (50.4)		
3	0.21	385 (10.8)	760 (21.3)	1160 (32.5)	1500 (42.0)	1620 (45.4)	2240 (62.7)		
5	0.34	510 (14.3)	1030 (28.8)	1480 (41.4)	1860 (52.1)	2150 (60.2)	2920 (81.8)		
10	0.69	715 (20.0)	1540 (43.1)	2240 (62.7)	2650 (74.2)	3200 (89.6)	4050 (113.4)		
20	1.38	1090 (30.5)	2300 (64.4)	3200 (89.6)	4000 (112.0)	4550 (127.4)	5150 (144.2)		
30	2.07	1400 (39.2)	2950 (82.6)	4080 (114.2)	4800 (134.4)	5300 (148.4)	5200 (145.6)		
40	2.76	1720 (48.2)	3580 (100.2)	4700 (131.6)	5200 (145.6)	5900 (165.2)			
50	3.45	2000 (56.0)	4000 (112.0)	4860 (136.1)	5700 (159.6)	6000 (168.0)			
60	4.14	2320 (65.0)	4500 (126.0)	5150 (144.2)	6300 (176.4)	6150 (172.2)			
75	5.17	2775 (77.7)	4795 (134.3)	5665 (158.6)	6520 (182.6)				
80	5.52	2995 (83.9)	4810 (134.7)	5800 (162.4)					
90	6.21	3200 (89.6)	4900 (137.2)	5850 (163.8)					
100	6.90	3300 (92.4)	5020 (140.6)	5900 (165.2)					
125	8.62	3500 (98.0)	5100 (142.8)	5900 (165.2)					

Lock-up Pressure <sup>A</sup>	14.5	14.5	14.7	15.3	15.5	16.0
-------------------------------	------	------	------	------	------	------

Notes:

A. Outlet pressure increase required for lock up in inches w.c.

 Inlet pressure is too low to achieve desired outlet pressure.

 Do not operate orifice in shaded inlet pressure area.

## B531 PERFORMANCE CURVES

### 14" w.c. Set Point

Type and model	B531R
Inlet size	1-1/4" NPT
Outlet size	2" NPT
Orifice size	1/4"
Spring color	Silver

Set point 14.0" w.c. with 40 PSIG inlet @ 200 SCFH. All test results are reported at a base of 14.7 PSIG at 60° F and with 0.6 S.G. gas.

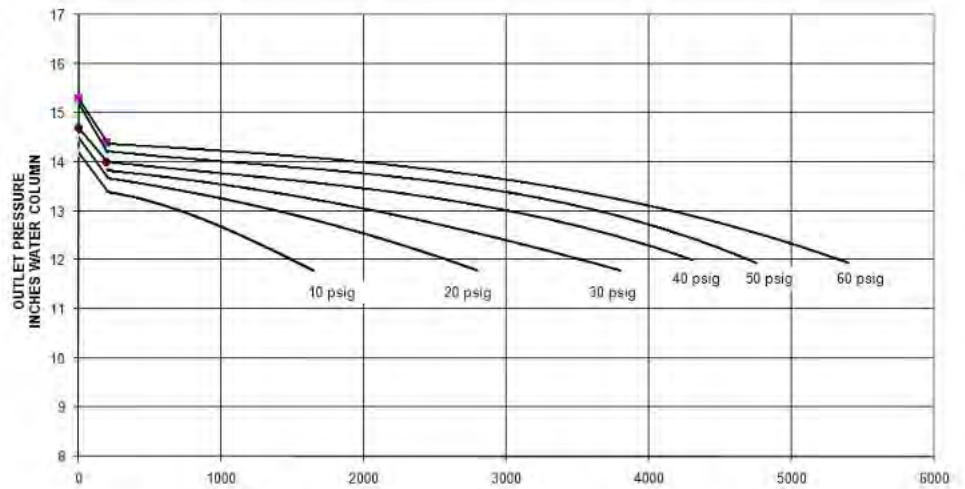

## B531 RELIEF CURVES R MODEL ONLY

### 14" w.c. Set Point

Type and model	B531R
Inlet size	1-1/4" NPT
Outlet size	2" NPT
Vent size	1" NPT

Set point 14.0" w.c. with 40 PSIG inlet @ 200 SCFH. All test results are reported at a base of 14.7 PSIG at 60° F and with 0.6 S.G. gas.

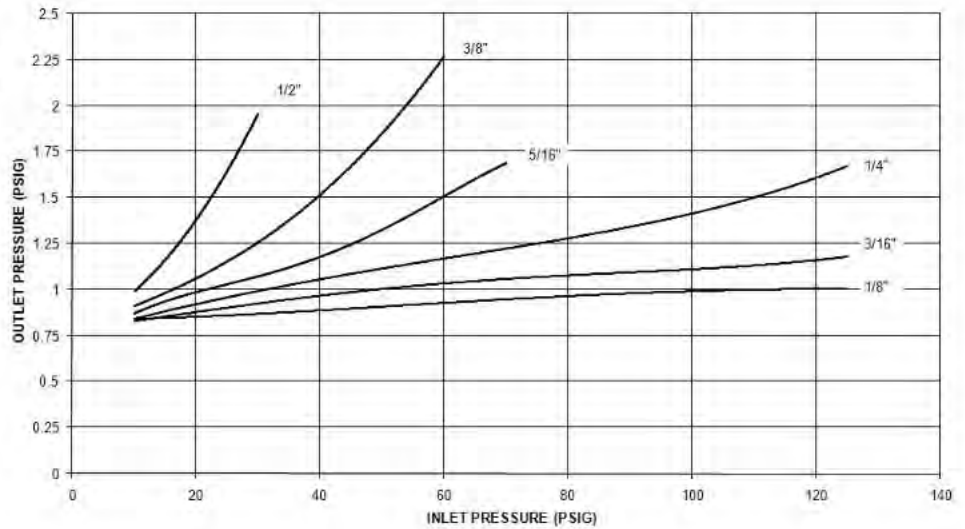

**B531 COMMERCIAL AND INDUSTRIAL REGULATOR, MODELS N AND R**

**Set Point 1 PSIG (69 mbar) @ 200 SCFH (5.68 m<sup>3</sup>/hr) Capacity Table (1% Droop), Valve Body 1-1/4" x 1-1/2"**

Capacities in SCFH (m<sup>3</sup>/hr) of 0.6 S.G. gas; base conditions of 14.7 PSIA and 60°F.

**Typical Capacity Info.**

Manufacturer	Itron
Type and model	B531R
Regulator	
Inlet size	1-1/4"
Outlet size	1-1/2"
Spring color	Varies
Position	5

Inlet Pressure		Orifice Size							
PSIG	Bar	1/8"	3/16"	1/4"	5/16"	3/8"	1/2"		
2	0.14	255 (7.1)	440 (12.3)	630 (17.6)	750 (21.0)	930 (26.0)	1100 (30.8)		
3	0.21	310 (8.7)	550 (15.4)	750 (21.0)	1050 (29.4)	1290 (36.1)	1400 (39.2)		
5	0.34	415 (11.6)	735 (20.6)	780 (21.8)	1100 (30.8)	1300 (36.4)	1650 (46.2)		
10	0.69	640 (17.9)	860 (24.1)	1120 (31.4)	1600 (44.8)	1800 (50.4)	2300 (64.4)		
20	1.38	890 (24.9)	1300 (36.4)	1650 (46.2)	2400 (67.2)	3000 (84.0)	3600 (100.8)		
30	2.07	1200 (33.6)	1800 (50.4)	2100 (58.8)	3100 (86.8)	3550 (99.4)	4100 (114.8)		
40	2.76	1500 (42.0)	2100 (58.8)	2300 (64.4)	3700 (103.6)	3950 (110.6)	4200 (117.6)		
50	3.45	1720 (48.2)	2800 (78.4)	2900 (81.2)	4000 (112.0)	4350 (121.8)	4800 (134.4)		
60	4.14	2000 (56.0)	3100 (86.8)	3700 (103.6)	4300 (120.4)	4600 (128.8)	4900 (137.2)		
70	4.83	2310 (64.7)	3585 (100.4)	4120 (115.4)	4601 (128.8)	4815 (134.8)			
80	5.52	2600 (72.8)	3730 (104.4)	4520 (126.6)	4972 (139.2)	5142 (144.0)			
90	6.21	2900 (81.2)	3890 (108.9)	4600 (128.8)	5310 (148.7)	5310 (148.7)			
100	6.90	3150 (88.2)	3990 (111.7)	4720 (132.2)	5700 (159.6)	5760 (161.3)			
125	8.62	3400 (95.2)	4170 (116.8)	4950 (138.6)	5900 (165.2)	5990 (167.7)			

Lock-up Pressure (PSIG) <sup>A</sup>	1.02	1.03	1.05	1.07	1.10	1.10
--------------------------------------	------	------	------	------	------	------

Note:

A. Outlet pressure increase required for lock up in PSIG.

Capacities above the dark line were achieved using a yellow spring.

Capacities below the dark line were achieved using a red-blue spring.

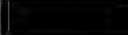
 Do not operate orifice in shaded inlet pressure area.

**B531 COMMERCIAL AND INDUSTRIAL REGULATOR, MODELS N AND R**

**Set Point 1 PSIG (69 mbar) @ 200 SCFH (5.68 m<sup>3</sup>/hr) Capacity Table (2% Absolute Droop), Valve Body 1-1/4" x 1-1/2"**

Capacities in SCFH (m<sup>3</sup>/hr) of 0.6 S.G. gas; base conditions of 14.7 PSIA and 60°F.

**Typical Capacity Info.**

Manufacturer	Itron
Type and model	B531R
Regulator	
Inlet size	1-1/4"
Outlet size	1-1/2"
Spring color	Yellow Red/blue
Position	5

Inlet Pressure		Orifice Size						
PSIG	Bar	1/8"	3/16"	1/4"	5/16"	3/8"	1/2"	
2	0.14	280 (7.8)	590 (16.5)	800 (22.4)	1000 (28.0)	1500 (42.0)	1900 (53.2)	
3	0.21	375 (10.5)	790 (22.1)	1000 (28.0)	1500 (42.0)	1800 (50.4)	2300 (64.4)	
5	0.34	530 (14.8)	1100 (30.8)	1250 (35.0)	1700 (47.6)	1950 (54.6)	2600 (72.8)	
10	0.69	750 (21.0)	1300 (36.4)	1900 (53.2)	2400 (67.2)	2950 (82.6)	3700 (103.6)	
20	1.38	1050 (29.4)	2050 (57.4)	2850 (79.8)	3900 (109.2)	4400 (123.2)	5300 (148.4)	
30	2.07	1400 (39.2)	2750 (77.0)	3710 (103.9)	4650 (130.2)	5100 (142.8)	6100 (170.8)	
40	2.76	1750 (49.0)	3350 (93.8)	4050 (113.4)	5400 (151.2)	5600 (156.8)	6800 (190.4)	
50	3.45	1950 (54.6)	4050 (113.4)	4800 (134.4)	6000 (168.0)	6000 (168.0)	7000 (196.0)	
60	4.14	2350 (65.8)	4500 (126.0)	5600 (156.8)	6100 (170.8)	6200 (173.6)	7100 (198.8)	
70	4.83	2675 (74.9)	4922 (137.8)	6099 (170.8)	6520 (182.6)	6630 (185.6)		
80	5.52	2995 (83.8)	5311 (148.7)	6498 (181.9)	6890 (192.9)	7006 (196.2)		
90	6.21	3190 (89.3)	5780 (161.8)	6670 (186.8)	7200 (201.6)	7315 (204.8)		
100	6.90	3410 (95.5)	6120 (171.4)	6800 (190.4)	7410 (207.5)	7500 (210.0)		
125	8.62	3700 (103.6)	6400 (179.2)	6950 (194.6)	7500 (210.0)	7500 (210.0)		

Lock-up Pressure (PSIG) <sup>A</sup>	1.02	1.03	1.05	1.07	1.10	1.10
--------------------------------------	------	------	------	------	------	------

Notes:

A. Outlet pressure increase required for lock up in PSIG.

Capacities above the dark line were achieved using a yellow spring.

Capacities below the dark line were achieved using a red-blue spring.

 Do not operate orifice in shaded inlet pressure area.

## B531 PERFORMANCE CURVES

### 1 PSIG Set Point

Type and model	B531R
Inlet size	1-1/4" NPT
Outlet size	2" NPT
Orifice size	1/4"
Spring color	Red/Gray

Set point 1 PSIG with 40 PSIG inlet @ 200 SCFH. All test results are reported at a base of 14.7 PSIG at 60° F and with 0.6 S.G. gas.

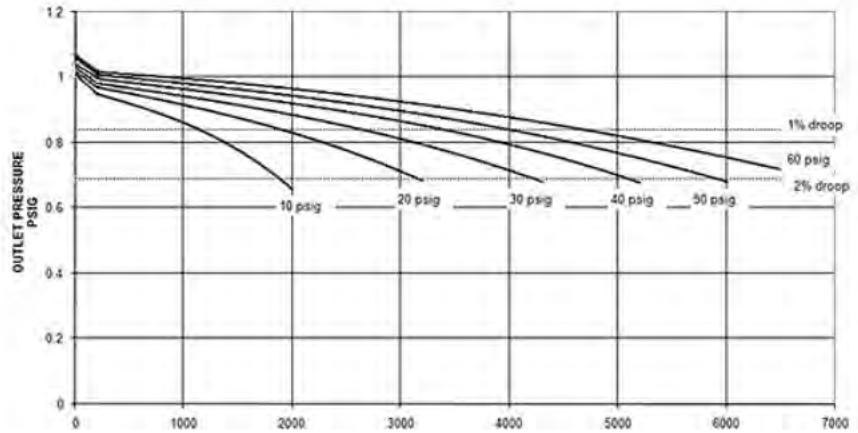

## B531 RELIEF CURVES R MODEL ONLY

### 1 PSIG Set Point

Type and model	B531R
Inlet size	1-1/4" NPT
Outlet size	2" NPT
Vent size	1" NPT

Set point 1 PSIG with 40 PSIG inlet @ 200 SCFH. All test results are reported at a base of 14.7 PSIG at 60° F and with 0.6 S.G. gas.

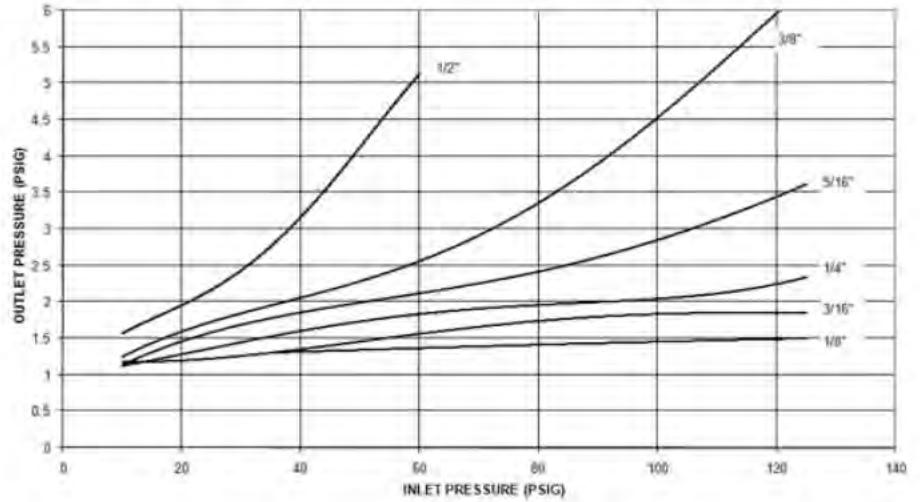

## B531 COMMERCIAL AND INDUSTRIAL REGULATOR, MODELS N AND R

### 2 PSIG Capacity Table (1% Absolute Droop), All valve bodies

Capacities in SCFH of 0.6 S.G. gas; base conditions of 14.7 PSIA and 60°F.

Typical Capacity Info.		Inlet Pressure		Orifice Size											
		PSIG	Bar	1/8"		3/16"		1/4"		5/16"		3/8"		1/2"	
Manufacturer	Itron	3	0.2	255	(7.1)	400	(11.2)	505	(14.1)	605	(16.9)	740	(20.7)	920	(25.8)
Type and model	B531	5	0.3	340	(9.5)	570	(16.0)	720	(20.2)	990	(27.7)	1100	(30.8)	1350	(37.8)
Regulator		10	0.7	540	(15.1)	850	(23.8)	1150	(32.2)	1480	(41.4)	1780	(49.8)	2100	(58.8)
Inlet size	1-1/4"	20	1.4	780	(21.8)	1230	(34.4)	1760	(49.3)	2200	(61.6)	2620	(73.4)	3100	(86.8)
Outlet size	1-1/2"	30	2.1	1050	(29.4)	1800	(50.4)	2300	(64.4)	2700	(75.6)	3350	(93.8)	4020	(112.6)
Spring color	White	40	2.8	1280	(35.8)	2100	(58.8)	2860	(80.1)	3300	(92.4)	3980	(111.4)	4400	(123.2)
Position	5	50	3.4	1450	(40.6)	2550	(71.4)	3160	(88.5)	3800	(106.4)	4380	(122.6)	4750	(133.0)
		60	4.1	1740	(48.7)	2620	(73.4)	3600	(100.8)	4000	(112.0)	4880	(136.6)	5600	(156.8)
		70	4.8	1712	(47.9)	2940	(82.3)	4250	(119.0)	4685	(131.2)	5300	(148.4)		
		80	5.5	1920	(53.8)	3220	(90.2)	4640	(130.0)	4910	(137.5)	5760	(161.3)		
		90	6.2	2120	(59.4)	3360	(94.1)	4820	(135.0)	5100	(142.8)	6200	(173.6)		
		100	6.9	2400	(67.2)	3480	(97.4)	4910	(137.5)	5220	(146.2)	6660	(186.5)		
		125	8.6	2590	(72.5)	3610	(101.1)	5150	(144.2)	5430	(152.0)	6820	(191.0)		

Lock-up pressure (PSIG) A	2.05	2.05	2.10	2.10	2.20	2.30
---------------------------	------	------	------	------	------	------

Notes:

A. Outlet pressure increase required for lock up in PSIG.

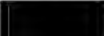
 Do not operate orifice in shaded inlet pressure area.



**B531 COMMERCIAL AND INDUSTRIAL REGULATOR, MODELS N AND R**

**2 PSIG (69 mbar) @ 200 SCFH (5.68 m3/hr) Capacity Table (2% Absolute Droop), All valve bodies**

Capacities in SCFH of 0.6 S.G. gas; base conditions of 14.7 PSIA and 60°F.

**Typical Capacity Info**

Manufacturer	Itron
Type and model	B531R
Regulator	
Inlet size	1-1/4"
Outlet size	1-1/2"
Spring color	White
Position	5

Inlet Pressure		Orifice Size											
PSIG	Bar	1/8"		3/16"		1/4"		5/16"		3/8"		1/2"	
3	0.2	285	(8.0)	545	(15.3)	785	(22.0)	1050	(29.4)	1180	(33.0)	1600	(44.8)
5	0.3	440	(12.3)	810	(22.7)	1180	(33.0)	1540	(43.1)	1780	(49.8)	2340	(65.5)
10	0.7	685	(19.2)	1330	(37.2)	1870	(52.4)	2380	(66.6)	2820	(79.0)	3780	(105.8)
20	1.4	1090	(30.5)	2060	(57.7)	2980	(83.4)	3700	(103.6)	4250	(119.0)	5350	(149.8)
30	2.1	1400	(39.2)	2820	(79.0)	3800	(106.4)	4650	(130.2)	5450	(152.6)	6500	(182.0)
40	2.8	1700	(47.6)	3420	(95.8)	4500	(126.0)	5500	(154.0)	6600	(184.8)	7500	(210.0)
50	3.4	2020	(56.6)	3920	(109.8)	4950	(138.6)	6400	(179.2)	7100	(198.8)	7500	(210.0)
60	4.1	2200	(61.6)	4380	(122.6)	5500	(154.0)	7000	(196.0)	7500	(210.0)	7500	(210.0)
70	4.8	2745	(76.9)	5010	(140.3)	6070	(170.0)	7465	(209.0)	7500	(210.0)		
80	5.5	3130	(87.6)	5450	(152.6)	6920	(193.8)	7500	(210.0)	7500	(210.0)		
90	6.2	3245	(90.9)	5780	(161.5)	7420	(207.8)	7500	(210.0)	7500	(210.0)		
100	6.9	3400	(95.2)	6000	(168.0)	7500	(210.0)	7500	(210.0)	7500	(210.0)		
125	8.6	3510	(98.3)	6160	(172.5)	7500	(210.0)	7500	(210.0)	7500	(210.0)		

Lock-up pressure (PSIG) <sup>A</sup>	2.05	2.05	2.10	2.10	2.20	2.30
--------------------------------------	------	------	------	------	------	------

Notes:

A. Outlet pressure increase required for lock up in PSIG

 Do not operate orifice in shaded inlet pressure area.

## B531 PERFORMANCE CURVES

### 2 PSIG Set Point

Type and model	B531R
Inlet size	1-1/4" NPT
Outlet size	2" NPT
Orifice size	1/4"
Spring color	White

Set point 2 PSIG with 40 PSIG inlet @ 200 SCFH. All test results are reported at a base of 14.7 PSIG at 60° F and with 0.6 S.G. gas.

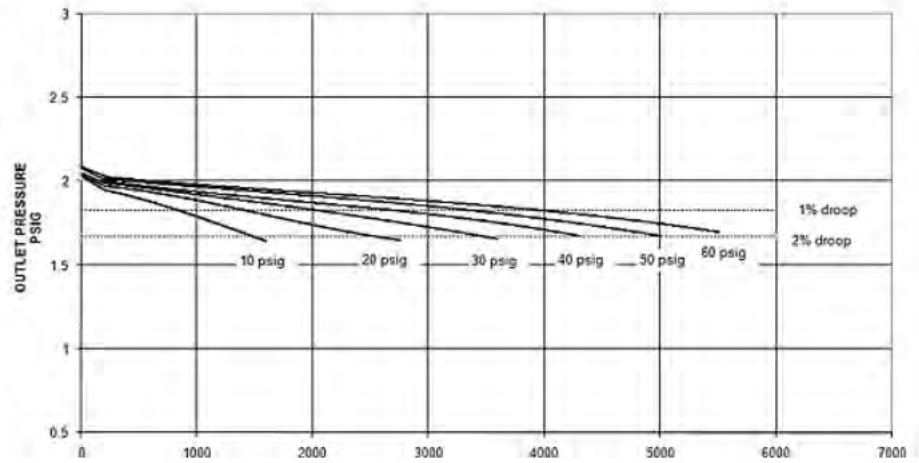

### B531 RELIEF CURVES R MODEL ONLY

#### 2 PSIG Set Point

Type and model	B531R
Inlet size	1-1/4" NPT
Outlet size	2" NPT
Vent size	1" NPT

Set point 2 PSIG with 40 PSIG inlet @ 200 SCFH. All test results are reported at a base of 14.7 PSIG at 60° F and with 0.6 S.G. gas.

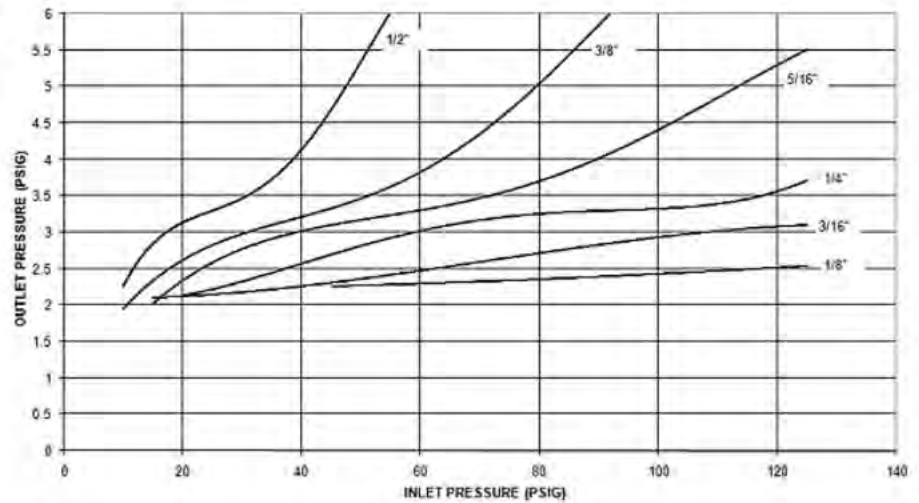

## B531 COMMERCIAL REGULATOR IM MODELS

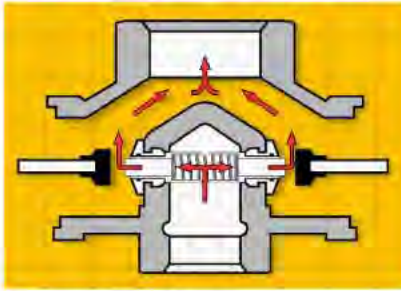

A. Normal regulation

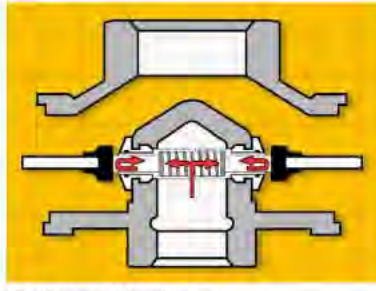

B. Normal lock-up

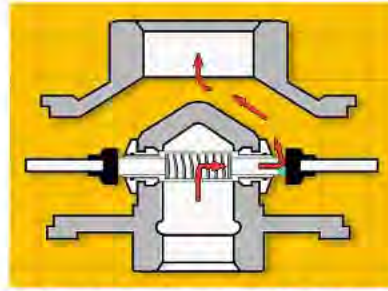

C. Dual monitor operation - internal foreign material failure

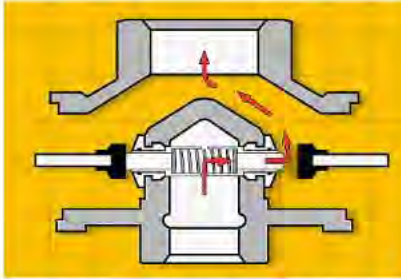

D. Single monitor operation, one full internal diaphragm case failure

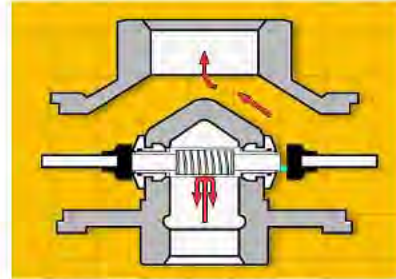

E. Internal monitor lock-up

### PRINCIPLE OF OPERATION

- Normal Operation.** The internal monitor (IM) orifice performs like a standard one-piece orifice, performing normal regulation. The upstream monitor remains wide-open.
- Normal Lock-up.** The regulator is free to lock-up in the usual manner. A nitrile o-ring forms a seal between the stationary and sliding orifices and prevents gas from leaking past the outer part of the orifice into the downstream or low pressure side of the valve body. The upstream monitor remains wide open.
- Monitor Operation.** The monitor is comprised of one sliding orifice with a brass sharp edge and another sliding orifice with a vulcanized nitrile valve seat. If either of the regulator's main valves fails to lock-up for any reason, the internal monitor orifice automatically goes into operation. Outlet pressure increases slightly, causing the valve seat to push against the inner or sliding part of the orifice, gradually compressing the monitor spring and closing the secondary or monitor orifice on the inlet side of the sliding orifices. At this point, the B531IM operates as a monitor regulator.

**C1. Foreign material failure.** Assume a weld bead is caught between the orifice and the valve seat while in high flow operation. If the flow is reduced, the main valve tries to close, but cannot due to the foreign matter. The outlet pressure increases approximately 2" w.c. above the original set point (varies based on main valve set point) which starts to close the secondary monitor orifice. If the gas demand is decreased, the monitor will be partially closed and becomes the new operating orifice. It will function as a monitor regulator keeping the outlet pressure approximately 3" w.c. above the set pressure for set pressure <1 PSIG or 0.5 PSIG for set pressure >1 PSIG.

**C2. Diaphragm or lever failure.** While diaphragm or lever failure is an entirely unlikely situation, if the event would happen, the damages side of the regulator will be unable to operate. The outlet pressure will then increase on the functional regulator and its sliding orifice moves to contact the monitor orifice and seat. However, since only one diaphragm is in operation, the outlet pressure will be about 4" w.c. higher on monitor operation than the normal set point.

- Monitor Lock-up (no demand).** If the demand for gas downstream of the regulator is zero, the sliding orifices or orifice will close against the secondary rubber monitor seat and stop the gas flow completely.
- Vent-hole "V" Option (not shown).** The sliding orifices of the IMRV model are equipped with 0.049" vent holes located near the sliding orifice's stepped portion. During monitor operation, if the demand is very small or non-existent, the 0.049" vent holes will allow gas to bleed from the high-pressure inlet side to the low-pressure outlet side of the regulator. The pressure will build until the internal relief valve cracks. The relief valve will weep gas to the atmosphere giving a warning indication the regulator is not operating properly.
- Regulator and Monitor Failure (not shown).** In the unlikely event both the regulator and monitor fail, the B531IMR is equipped with twin internal relief valves that will be actuated by the stop stem.

		Internal Monitor Lock-up and Relief Data	
Set Point	Spring	IMN and IMR Lock-up <sup>1</sup>	IMRV Relief Point <sup>2</sup>
7" w.c.	Black	12" w.c.	16" w.c.
14" w.c.	White/Red	24" w.c.	27" w.c.
1 PSIG	White/Red	1.4 PSIG	1.7 PSIG
2 PSIG	White	2.6 PSIG	2.8 PSIG

Note: Regulator failed with 1/4" plastic glued to seat.

1. Outlet pressure required for internal monitor to close.

2. Outlet pressure required to open the internal relief valve.

**B531 COMMERCIAL AND INDUSTRIAL REGULATOR, MODELS IMN AND IMR**

7" w.c. (17.5 mbar) @200 SCFH (5.68 m<sup>3</sup>/hr) Capacity Table (1" Droop), Valve Body 1-1/4" x 1-1/2"

Capacities in SCFH of 0.6 S.G. gas, base conditions of 14.7 PSIA and 60°F

Typical Capacity Info		Inlet Pressure		Orifice Size							
		PSIG	Bar	1/8"		3/16"		1/4"		5/16"	
Manufacturer	Itron										
Type and model	B531IM	1	0.1			375	(10.5)	570	(16.0)	650	(18.2)
Regulator		2	0.1	275	(7.7)	575	(16.1)	875	(24.5)	950	(26.6)
Inlet size	1-1/4"NPT	3	0.2	350	(9.8)	700	(19.6)	1100	(30.8)	1200	(33.6)
Outlet size	1-1/2" NPT	5	0.3	500	(14.0)	975	(27.3)	1350	(37.8)	1600	(44.8)
Spring color	Black	10	0.7	700	(19.6)	1400	(39.2)	2000	(56.0)	2300	(64.4)
Position	5	15	1.0	950	(26.6)	1900	(53.2)	2500	(70.0)	2800	(78.4)
		25	1.7	1300	(36.4)	2600	(72.8)	3000	(84.0)	3200	(89.6)
		40	2.8	1750	(49.0)	3200	(89.6)	3200	(89.6)	3200	(89.6)
		60	4.1	2400	(67.2)	3200	(89.6)	3200	(89.6)	3200	(89.6)
		75	5.2	2900	(81.2)	3200	(89.6)				
		90	6.2	3150	(88.2)	3200	(89.6)				
		100	6.9	3200	(89.6)	3200	(89.6)				
		125	8.6	3200	(89.6)	3200	(89.6)				

Lock-up pressure (inches w.c.)	7.5	7.6	7.7	7.8
--------------------------------	-----	-----	-----	-----

Notes:

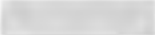
 Inlet pressure is too low to achieve desired outlet pressure.

 Do not operate orifice in shaded inlet pressure area.

**B531 COMMERCIAL AND INDUSTRIAL REGULATOR, MODELS IMN AND IMR**

**7" w.c. (17.5 mbar) @200 SCFH (5.68 m<sup>3</sup>/hr) Capacity Table (1" Droop), Valve Body 1-1/4" x 2"**

Capacities in SCFH of 0.6 S.G. gas; base conditions of 14.7 PSIA and 60°F.

**Typical Capacity Info.**

Manufacturer	Itron
Type and model	B531IM
Regulator	
Inlet size	1-1/4"
Outlet size	2"
Spring color	Black
Position	5

Inlet Pressure		Orifice Size							
PSIG	Bar	1/8"		3/16"		1/4"		5/16"	
1	0.07			375	(10.5)	570	(16.0)	650	(18.2)
2	0.14	275	(7.7)	575	(16.1)	875	(24.5)	950	(26.6)
3	0.21	350	(9.8)	700	(19.6)	1100	(30.8)	1200	(33.6)
5	0.34	500	(14.0)	975	(27.3)	1350	(37.8)	1600	(44.8)
10	0.69	700	(19.6)	1400	(39.2)	2000	(56.0)	2500	(70.0)
20	1.38	1100	(30.8)	2200	(61.6)	3200	(89.6)	3800	(106.4)
30	2.07	1400	(39.2)	2900	(81.2)	4200	(117.6)	4400	(123.2)
40	2.76	1750	(49.0)	3600	(100.8)	4700	(131.6)	5000	(140.0)
50	3.45	2000	(56.0)	4100	(114.8)	5000	(140.0)	5000	(140.0)
60	4.14	2400	(67.2)	5000	(140.0)	5000	(140.0)	5000	(140.0)
70	4.83	2600	(72.8)	5000	(140.0)				
80	5.52	2900	(81.2)	5000	(140.0)				
90	6.21	3200	(89.6)	5000	(140.0)				
100	6.90	3500	(98.0)	5000	(140.0)				
125	8.62	4000	(112.0)	5000	(140.0)				

Lock-up pressure (inches w.c.)	7.5	7.6	7.7	7.8
--------------------------------	-----	-----	-----	-----

Notes:

- Inlet pressure is too low to achieve desired outlet pressure.
- Do not operate orifice in shaded inlet pressure area.

**B531 COMMERCIAL AND INDUSTRIAL REGULATOR, MODELS IMN AND IMR**

**14" w.c. (35 mbar) @ 200 SCFH (5.68 m<sup>3</sup>/hr) Capacity Table (2" Droop), All valve bodies**

Capacities in SCFH (m<sup>3</sup>/hr) of 0.6 S.G. gas; base conditions of 14.7 PSIA and 60°F.

**Typical Capacity Info.**

Manufacturer	Itron
Type and model	B5311
Regulator	
Inlet size	1-1/4"
Outlet size	1-1/2"
Spring color	Black
Position	5

Inlet Pressure		Orifice size							
PSIG	Bar	1/8"		3/16"		1/4"		5/16"	
1	0.07			290	(8.1)	350	(9.8)	410	(11.5)
2	0.14	265	(7.4)	370	(10.4)	460	(12.9)	595	(16.7)
3	0.21	315	(8.8)	455	(12.7)	550	(15.4)	720	(20.2)
5	0.34	415	(11.6)	545	(15.3)	715	(20.2)	920	(25.8)
10	0.69	575	(16.1)	775	(21.7)	1030	(28.8)	1220	(34.2)
15	1.03	680	(19.0)	1030	(28.8)	1280	(35.8)	1620	(45.4)
20	1.38	850	(23.8)	1230	(34.4)	1430	(40.0)	1980	(55.4)
30	2.07	1100	(30.8)	1700	(48.1)	2020	(56.6)	2550	(71.4)
40	2.76	1420	(39.8)	2160	(60.5)	2420	(67.8)	3020	(84.6)
50	3.45	1750	(49.0)	2400	(67.2)	2740	(76.7)	3400	(95.2)
60	4.14	2100	(58.8)	2850	(80.0)	3000	(84.0)	3500	(98.0)
75	5.17	2500	(70.0)	3220	(90.2)				
85	5.86	2780	(77.8)	3520	(98.6)				
100	6.90	2910	(81.5)	4200	(118.0)				
125	8.62	3550	(99.4)	5120	(143.3)				

Lock-up Pressure (inches w.c.)	14.5	14.6	14.7	15.3
--------------------------------	------	------	------	------

Notes:

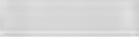
 Inlet pressure is too low to achieve desired outlet pressure.

 Do not operate orifice in shaded inlet pressure area.

**B531 COMMERCIAL AND INDUSTRIAL REGULATOR, MODELS IMN AND IMR**

**1 PSIG Capacity Table (1% Absolute Droop), All valve bodies**

Capacities in SCFH (m3/hr) of 0.6 S.G. gas; base conditions of 14.7 PSIA and 60°F

**Typical Capacity Info.**

<b>Manufacturer</b>	Itron
<b>Type and model</b>	B531IM
<b>Regulator</b>	
Inlet size	All
Outlet size	All
Spring color	White/red
<b>Position</b>	5

Inlet Pressure		Orifice size							
PSIG	Bar	1/8"		3/16"		1/4"		5/16"	
2	0.14			385	(10.8)	485	(13.6)	590	(16.5)
3	0.21	320	(9.0)	500	(14.0)	580	(16.2)	740	(20.7)
5	0.34	425	(11.9)	600	(16.8)	760	(21.3)	980	(27.4)
10	0.69	625	(17.5)	920	(25.8)	1060	(29.7)	1500	(42.0)
15	1.03	790	(22.1)	1230	(34.4)	1420	(39.8)	1920	(53.8)
20	1.38	990	(27.7)	1410	(39.5)	1720	(48.2)	2280	(63.8)
30	2.07	1280	(35.8)	1880	(52.6)	2320	(65.0)	3000	(84.0)
40	2.76	1660	(46.5)	2380	(66.6)	2850	(79.8)	3520	(98.6)
50	3.45	1880	(52.6)	2840	(79.5)	3220	(90.2)	3940	(110.3)
60	4.14	2260	(63.3)	3150	(88.2)	3520	(98.6)	4350	(121.8)
75	5.17	2700	(75.6)	3760	(105.3)				
85	5.86	2940	(82.3)	4000	(112.0)				
100	6.90	3320	(93.0)	4700	(131.6)				
125	8.62	4050	(113.4)	5720	(160.2)				

Lock-up pressure (inches w.c.)	1.02	1.03	1.05	1.07
--------------------------------	------	------	------	------

Notes:

Inlet pressure is too low to achieve desired outlet pressure.

Do not operate orifice in shaded inlet pressure area.



**B531 COMMERCIAL AND INDUSTRIAL REGULATOR, MODELS IMN AND IMR**

**1 PSIG Capacity Table (2% Absolute Droop), All valve bodies**

Capacities in SCFH (m3/h) of 0.6 S.G. gas; base conditions of 14.7 PSIA and 60°F.

Typical Capacity Info.		Inlet Pressure		Orifice size										
		PSIG	Bar	1/8"		3/16"		1/4"		5/16"				
Manufacturer	Itron													
Type and model	B531IM	2	0.14			520	(14.6)	675	(18.9)	825	(23.1)			
Regulator		3	0.21	380	(10.6)	640	(17.9)	860	(24.1)	1080	(30.2)			
Inlet size	1-1/4"	5	0.34	525	(14.7)	640	(24.2)	1180	(33.0)	1450	(40.6)			
Outlet size	1-1/2"	10	0.69	750	(21.0)	1350	(37.8)	1700	(47.6)	2240	(62.7)			
Spring color	White	15	1.03	930	(26.0)	1720	(48.2)	2200	(61.6)	2800	(78.4)			
Position	5	20	1.38	1100	(30.8)	2100	(58.8)	2700	(75.6)	3480	(97.4)			
		30	2.07	1450	(40.6)	2840	(79.5)	3620	(101.4)	4400	(123.2)			
		40	2.76	1800	(50.4)	3500	(98.0)	4300	(120.4)	5200	(145.6)			
		50	3.45	2080	(58.2)	4000	(112.0)	4800	(134.4)	5800	(162.4)			
		60	4.14	2320	(65.0)	4500	(126.0)	5350	(149.8)	6200	(173.6)			
		75	5.17	2890	(80.9)	5280	(147.8)							
		85	5.86	3270	(91.6)	5630	(157.6)							
		100	6.90	3670	(102.7)	6880	(192.6)							
		125	8.61	4470	(125.2)	8380	(234.6)							

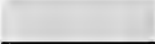
Lock-up pressure (inches w.c.)	1.02	1.03	1.05	1.07
--------------------------------	------	------	------	------

 Inlet pressure is too low to achieve desired outlet pressure.  
 Do not operate orifice in shaded inlet pressure area.



**B531 COMMERCIAL AND INDUSTRIAL REGULATOR, MODELS IMN AND IMR**

**2 PSIG Capacity Table (1% Absolute Droop), All valve bodies**

Capacities in SCFH (m3/H) of 0.6 S.G. gas; base conditions of 14.7 PSIA and 60°F.

**Typical Capacity Info.**

Manufacturer	Itron
Type and model	B531IM
Regulator	
Inlet size	All
Outlet size	All
Spring color	White
Position	5

Inlet Pressure		Orifice size							
PSIG	Bar	1/8"		3/16"		1/4"		5/16"	
3	0.21			375	(10.5)	450	(12.6)	570	(16.0)
5	0.34	380	(10.6)	530	(14.8)	630	(17.6)	830	(23.2)
10	0.69	570	(16.0)	775	(21.7)	1000	(28.0)	1300	(36.4)
15	1.03	735	(20.6)	940	(26.3)	1220	(34.2)	1640	(45.9)
20	1.38	900	(25.2)	1220	(34.2)	1550	(43.4)	1880	(52.6)
30	2.07	1200	(33.6)	1660	(46.5)	1950	(54.6)	2640	(73.9)
40	2.76	1460	(40.9)	2150	(60.2)	2650	(71.7)	3280	(91.8)
50	3.45	1700	(47.6)	2450	(68.6)	2780	(77.8)	3700	(103.6)
60	4.14	1980	(55.4)	2860	(80.1)	3300	(92.4)	3900	(109.2)
75	5.17	2450	(68.6)	3350	(93.8)				
85	5.86	2730	(76.4)	3730	(104.4)				
100	6.90	3040	(85.1)	4350	(121.8)				
125	8.64	3700	(103.6)	5300	(148.4)				

Lock-up pressure (inches w.c.)	2.05	2.05	2.10	2.10
--------------------------------	------	------	------	------

Notes:

- Inlet pressure is too low to achieve desired outlet pressure.
- Do not operate orifice in shaded inlet pressure area.

**B531 COMMERCIAL AND INDUSTRIAL REGULATOR, MODELS IMN AND IMR**

**2 PSIG Capacity Table (2% Absolute Droop), All valve bodies**

Capacities in SCFH (m3/hr) of 0.6 S.G. gas; base conditions of 14.7 PSIA and 60°F.

**Typical Capacity Info.**

Manufacturer	Itron
Type and model	B531IM
Regulator	
Inlet size	1-1/4"
Outlet size	1-1/2"
Spring color	White
Position	5

Inlet pressure		Orifice size							
PSIG	Bar	1/8"		3/16"		1/4"		5/16"	
3	0.21			510	(14.3)	670	(18.8)	770	(21.6)
5	0.34	450	(12.6)	725	(20.3)	960	(26.9)	1210	(33.9)
10	0.69	725	(20.3)	1180	(33.0)	1500	(42.0)	1920	(53.8)
15	1.03	920	(25.8)	1490	(41.7)	1960	(54.9)	2550	(71.4)
20	1.38	1090	(30.5)	1880	(52.6)	2400	(67.2)	3050	(85.4)
30	2.07	1450	(40.6)	2520	(70.6)	3300	(92.4)	4120	(115.4)
40	2.76	1740	(48.7)	3250	(91.0)	3950	(110.6)	5000	(140.0)
50	3.45	2080	(58.2)	3700	(103.6)	4560	(127.7)	5700	(159.6)
60	4.14	2380	(66.6)	4180	(117.0)	4900	(137.2)	6000	(168.0)
75	5.17	2920	(81.8)	4770	(133.6)				
85	5.86	3240	(90.7)	5220	(146.2)				
100	6.90	3670	(102.8)	6300	(176.4)				
125	8.64	4470	(125.2)	7680	(215.0)				

Lock-up pressure (inches w.c.)	2.05	2.05	2.10	2.10
--------------------------------	------	------	------	------

Notes:

Inlet pressure is too low to achieve desired outlet pressure.

Do not operate orifice in shaded inlet pressure area.

**B531 PARTS LIST SCHEMATIC**

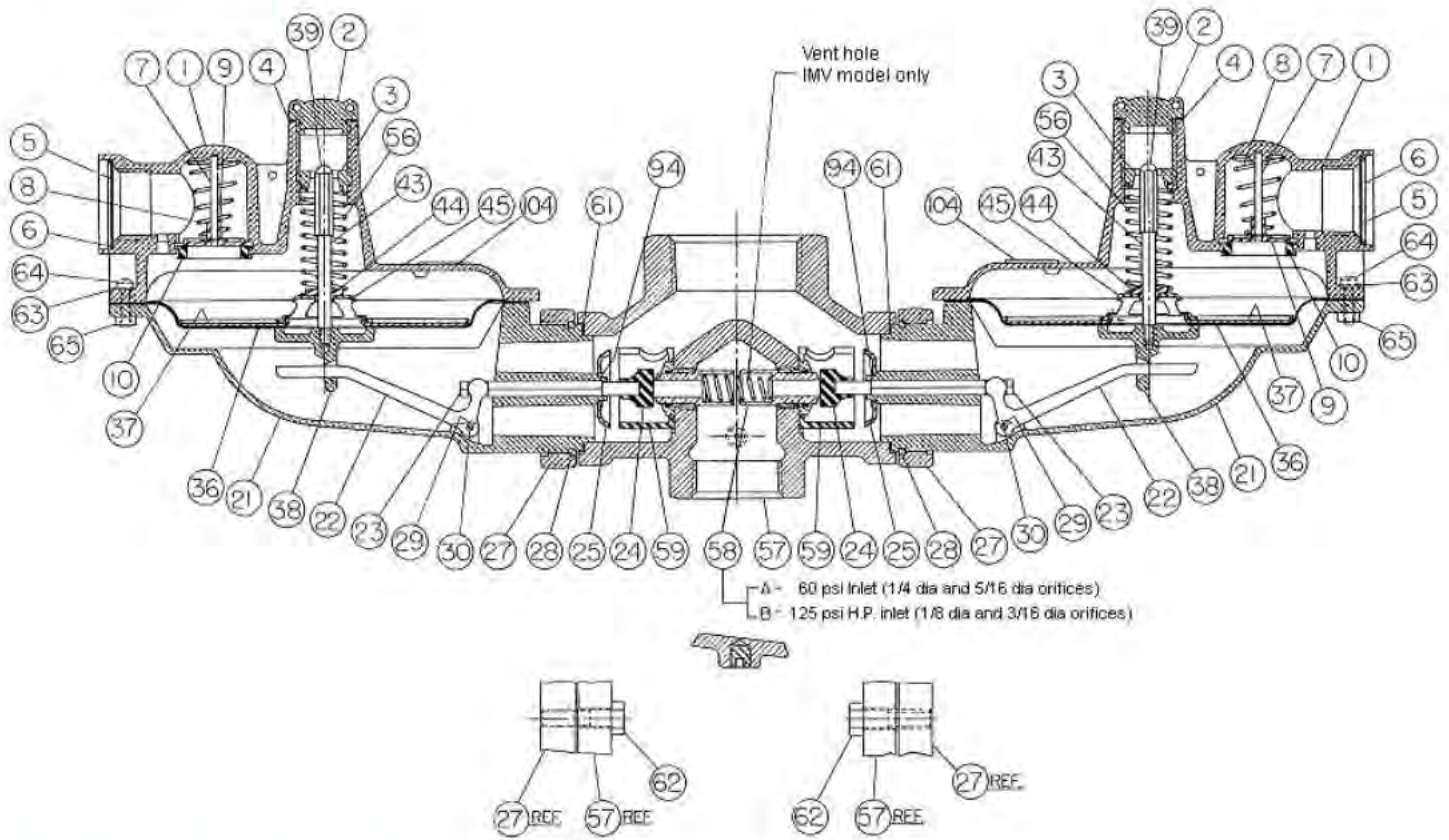

**B531 PARTS LIST, MODELS N AND R**

Item Number	Part Number	N	R	Description
1		2	2	Upper diaphragm case, please specify vent pipe size
	753107			Vent, 1/4" pipe/HP
	753130			Vent, 3/4" pipe/HP
	753142			Vent, 1/2" pipe/HP
	753157			Vent, 3/4" pipe/HP
	753207			Vent, 1" pipe/HP (standard)
2	760053	2	2	Seal cap (<1 PSIG)
	760055			Seal cap (HP)
3	760217	2	2	Adjustment screw, aluminum
4	765503	2	2	Seal cap gasket Note: for indoor installation of regulator, use seal cap gasket, P/N 765773 (leak permanent seal)
5		2	2	Vent screen, please specify vent size
	762935			For all vents except 1" vent, wire mesh
	762933			For 1" vent only, wire mesh
6		2	2	Vent screen retainer ring, please specify size
	75572701			For all vents except 1" vent
	75579101			For 1" vent only
7		2	2	Vent valve disc pin, please specify size
	754806			For all vents except 1" vent
	75483401			For 1" vent only
8	762601	2	2	Vent valve spring
9	765181	2	2	Vent valve disc

Item Number	Part Number	N	R	Description
10	765685	2	2	Vent valve seat
21	752324	2	2	Lower diaphragm case, all ratio
22	761231	2	2	Valve linkage lever, all ratio
	761241			Valve linkage, 4:1 ratio, IM
23	754021	2	2	Valve stem, aluminum
24	765021	2	2	Valve seat Buna N ThP
	765027			Valve seat 85 Durometer, IM
	765029			Valve seat brown silicone
25	761711	2	2	Deflector
27	751913	2	2	Valve body retainer plate
28	755725	2	2	Retainer plate snap ring
29	755141	4	4	Valve linkage pin screw
30	754831	2	2	Valve linkage pin
36	766121	2	2	Diaphragm
37	76102601	2	2	Upper diaphragm plate
38	756043	2	2	Lower diaphragm plate
39A	754301		2	Stop stem - short hex
39B	754303	2		Stop stem - long hex
43	762101		2	Relief spring, 7" w.c. above set (standard)
44	75490601	2	2	Stop stem guide bushing
45	761663	2	2	Relief cap
50	765775	-	2	Diaphragm gasket (optional)
54	755801	2	-	Diaphragm plate washer
56		2	2	Adjustment spring, please specify
	762111			Brown 4.5 -5.25 w.c.
	762115			Brown/white
	762117			Dark green 5.0 - 6.75 w.c.
	762119			Light green 5.5 - 7.50 w.c.
	762123			Black 7.0 - 10.0 w.c.
	762127			Blue 8.0 -11.0 w.c.
	762129			Silver 11.0 - 15.0 w.c.
	762131			Yellow 1.1 - 1.5 PSIG
	762135			Red 1.3 - 2.0 PSIG
	762137			White 1.75 - 2.5 PSIG
	762139			Gray
	762025			Red/gray 0.75 - 1.1 PSIG
	762018			Red/blue
57		1	1	Valve body, double, please specify size
	750903			3/4" x 1-1/4"
	750904			1" x 1-1/2" NPT
	750905			3/4" x 3/4"
	750906			3/4" x 3/4" with 1/8" tap
	750907			1" x 1-1/2" NPT with 1/4" NPT pipe plug
	750915			1" x 2" NPT
	750918			1" x 2" NPT with 1/8" NPT pipe plug
	750933			1-1/4" x 1-1/2" NPT

Item Number	Part Number	N	R	Description
				Valve body, double, please specify size (continued)
	750936			1-1/4" x 1-1/2" NPT with 1/8" NPT pipe plug
	750944			1-1/4" x 2" NPT
	750947			1-1/4" x 2" NPT with 1/8" NPT pipe plug
58		2	2	Orifice*, aluminum, please specify size
	757213			1/8" diameter
	757219			3/16" diameter
	757225			1/4" diameter
	757231			5/16" diameter
	757237			3/8" diameter
	757451			1/2" diameter
59	761751	2	2	Loading ring
61	765753	2	2	Valve body gasket
62	755381	4	4	Retainer plate screw, hex head 5/16" - 18" steel
63	769151	2	2	Curved regulator plate, silk screen & embossed
64	755304	16	16	Case screw, hex head
65	755661	16	16	Case screw nut, square
94	755785	2	2	Deflector retainer ring

Notes:

\*For Brass Orifice, additional charge.

#### Torque Specifications

Margin Screws	27 - 30 in. lbs.
Retainer Plate Screws	85 - 115 in. lbs.
Orifice	450 - 500 in. lbs.

#### B531 PARTS LIST, MODELS IMN, IMR, AND IMRV

Item Number	Part Number	Quantity			Description
		IMN	IMR	IMRV	
1	753207	2	2	2	Upper diaphragm case vent, 1" pipe
	753107	2	2	2	Upper diaphragm case vent, 1/4" pipe
2	760053	2	2	2	Seal cap, <1 PSIG
	760055	2	2	2	Seal cap, HP, >1 PSIG
3	760217	2	2	2	Adjustment screw, aluminum
4	765503	2	2	2	Seal cap gasket
5	762933	2	2	2	Vent screen
	762935	2	2	2	Vent Screen 3/4" vent
6	75579101	2	2	2	Vent screen retainer ring, 1" vent
	75572701				Vent screen retainer ring, 3/4" vent
7	75483401	2	2	2	Vent valve disc pin, 1" vent
	754806				Vent valve disc pin, 3/4" vent
8	762601	2	2	2	Vent valve spring, 1/2 oz
9	765181	2	2	2	Vent valve disc
10	765685	2	2	2	Vent valve seat
21	752324	2	2	2	Lower diaphragm case, 4.1 ratio
22	761241	2	2	2	Valve linkage lever, 4.1 ratio
23	754021	2	2	2	Valve stem, aluminum
24	765027	2	2	2	Valve seat, Buna "N", 85D
	765029				Valve seat, silicone, low temperature

Item Number	Part Number	Quantity			Description
		IMN	IMR	IMRV	
25	761711	2	2	2	Deflector
27	751913	2	2	2	Valve body retainer plate
28	755725	2	2	2	Retainer plate snap ring
29	755141	4	4	4	Valve linkage pin screw
30	754831	2	2	2	Valve linkage pin
36	766121	2	2	2	Diaphragm
37	76102601	2	2	2	Upper diaphragm plate
38	756043	2	2	2	Lower diaphragm plate
39		2	2	2	Stop stem, please specify size
	754303	-	2	2	Stop stem, short hex
	754325	2		-	Stop stem, long hex
43	762101	-	2	2	Relief spring 7" w.c. above set
44	75490601	2	2	2	Stop stem guide bushing
45	761663	2	2	2	Relief cap
54	755801	2	-	-	Diaphragm plate washer
56		2	2	2	Adjustment spring, specify color
	762018				Red/blue
	762030				Red/white
	762111				Brown 4.5" - 5.25" w.c.
	762115				Brown/white
	762117				Dark green 5.0" - 6.75" w.c.
	762119				Light green 5.5" - 7.50" w.c.
	762123				Black 7.0" - 10.0" w.c.
	762127				Blue 8.0" - 11.0" w.c.
	762129				Silver 11.0" - 15.0" w.c.
	762131				Yellow 1.1 - 1.5 PSIG
	762135				Red 1.3 - 2.0 PSIG
	762137				White 1.75 - 2.5 PSIG
	762139				Gray 4.0" - 9.0" w.c. (Canada only)
	762025				Red/gray 10" - 25" w.c.
	762029				White (short) .5 - 1.2 PSIG
57		1	1	1	Valve body, double, please specify size
	750903				3/4" x 1-1/4"
	750904				1 x 1-1/2 NPT
	750905				3/4" x 3/4"
	750906				3/4" x 3/4" with 1/8" tap
	750907				1" x 1-1/2" NPT with 1/4" NPT pipe plug
	750915				1" x 2" NPT
	750918				1" x 2" NPT with 1/8" NPT pipe plug
	750933				1-1/4" x 1-1/2" NPT
	750936				1-1/4" x 1-1/2" NPT with 1/8" NPT pipe plug
	750944				1-1/4" x 2" NPT
	750947				1-1/4" x 2" NPT with 1/8" NPT pipe plug

Item Number	Part Number	Quantity			Description
		IMN	IMR	IMRV	
58		1	1	1	Orifice assembly, sliding, please specify size
					For 60 PSI inlet
	759061	x	x		1/4" diameter IM
	759063			x	1/4" diameter IM with vent hole
	759065	x	x		5/16" diameter IM
	759067			x	5/16" diameter IM with vent hole
					For 125 PSI inlet
	759071	x	x		1/8" diameter IM
	759073			x	1/8" diameter IM with vent hole
	759075	x	x		3/16" diameter IM
	759077			x	3/16" diameter IM with vent hole
59	761751	2	2	2	Loading ring
61	765753	2	2	2	Valve body gasket
62	755381	4	4	4	Retainer plate screw, hex head
63	769151	2	2	2	Curved regulator plate
64	755304	16	16	16	Case screw, hex head
65	755661	16	16	16	Case screw nut, square
94	755785	2	2	2	Deflector retaining ring

Part No.	Special Tools
799051	Spring adjustment wrench
799015	Orifice wrench

Note: For indoor installation to regulator, use seal cap gasket #765773 leak proof seal. Remove items 5 and 6 to pipe vent outdoors.

#### Torque Specifications

Margin Screws	27-30 in. lbs.
Retainer Plate Screws	85-115 in. lbs.
Orifice Assemblies	250-300 in. lbs.

## VENT LINES FOR REGULATORS

When constructing vent lines to be attached to regulators installed indoors, follow a few basic rules:

- Never use pipe sizes smaller than the vent size; smaller pipe sizes restrict the gas flow. If a long gas run must be used, Itron advises increasing the pipe one nominal size every ten feet to keep the flow restriction as low as possible.
- Keep the vent line length as short as possible to minimize the restriction and reduce the vent's tendency to cause regulator pulsation.
- Support the vent pipe to eliminate strain on the regulator diaphragm case.
- Always point outdoor vent pipes in the downward position to reduce the possibility of rain, snow, sleet, and other moisture entering the pipe. Install a bug screen in the end of the pipe.
- Do not locate the vent line terminus near windows, fans, or other ventilation equipment. See the installation instructions furnished with the regulator.
- Adhere to all applicable codes and regulations.
- If your vent pipe causes regulator pulsation, consult your sales representative or manufacturer.
- Itron strongly recommends running a separate vent line for each regulator. Headers with various installed devices can cause regulator malfunction.

**Caution** Ensure the end of the vent line is away from ANY potential ignition sources. It is the installer's responsibility to verify the vent line is exhausting to a safe environment.

## INSTALLATION

**Warning** Itron does not endorse or warrant the completeness or accuracy of any third party regulator installation procedures or practices, unless otherwise provided in writing by Itron. Follow your company's standard operating procedures regarding the use of personal protection equipment (PPE). Adhere to guidelines issued by your company in addition to those given in this document when installing regulators.

- a. Remove all shipping plugs from the regulator inlet, outlet, and vent before installation.
- b. Verify the piping interior and regulator inlet and outlet are clean and free of dirt, pipe dope, and other debris. Dirt and other foreign materials entering the regulator can cause a loss of pressure control.
- c. Apply pipe joint sealant to the male pipe threads. Do not use pipe joint material on the regulator's female threads. Joint sealant could become lodged in the regulator and cause a loss of pressure control.
- d. Gas must flow through the regulator's valve body in the direction cast on the regulator body. Gas flowing in the wrong direction can overpressure and cause damage to the regulator.
- e. The pilot diaphragm casing can be mounted in any position relative to the body through a full 360° angle at 90° increments.
- f. When the regulator is installed OUTDOORS, the vent must always be positioned so that rain, snow, moisture or foreign particles cannot enter the vent opening. Itron recommends positioning the pilot vent downward to avoid entry of water or other matter which could interfere with the proper operation of the regulator. The vent should be located away from building eaves, window openings, building air intakes and above the expected snow level at the site. The vent opening should be inspected periodically to insure it does not become blocked by foreign material as outlined in DOT PHMSA-RSPA-2004-19856.
- g. When the regulator is installed INDOORS, the vent must be piped to the outside atmosphere using the shortest length of pipe, the fewest possible pipe elbows, and a pipe diameter as large as the vent size or larger. USING VENT PIPE SMALLER THAN THE VENT CONNECTION LIMITS THE REGULATOR'S INTERNAL RELIEF VALVE CAPACITY. The outlet end of the pipe must be protected from moisture and the entrance of foreign particles. The regulator should be specified by the user with the size vent and pipe threads desired to make the vent pipe connection.

## START-UP PROCEDURE

- a. Mount a pressure gauge downstream of the regulator to monitor the downstream pressure.
- b. With the downstream pressure valve closed, slowly open the inlet valve. The outlet pressure should rise to slightly more than the set-point. Verify there are no leaks and all connections are tight.
- c. The regulator was pre-set at the factory to match order specifications. If necessary, adjust the outlet pressure by removing the seal cap on the top of the pilot spring housing and adjusting the ferrule or screw inside the pilot spring housing using a large flat-head screwdriver. With a small amount of gas flowing through the regulator, rotate the pilot ferrule clockwise to raise the outlet pressure or counter-clockwise to lower the outlet pressure.
- d. Replace the seal cap and check for leaks after the desired outlet pressure is achieved.

The regulator is ready for operation.

## SAFETY WARNING

This product, as of the date of manufacture, is designed and tested to conform to all governmental and industry safety standards as they may apply to the manufacturer. The purchaser/user of this product must comply with all fire control, building codes, and other safety regulations governing the application, installation, operation, and general use of this regulator to avoid leaking gas hazards resulting from improper installation, startup or use of this product.

Itron strongly recommends installation by a qualified professional and periodic inspection of pressure regulators (inspections may be required by local applicable codes or regulations).

Inspections should include checking for gas quality, cycle numbers, external environmental changes, and operating conditions that impact wear on the regulator's moving parts. To ensure safe and efficient operation of this product, replace worn or damaged parts found during inspection.



## LIMITED WARRANTY

Itron, Inc. 970 Highway 127 North, Owenton, Kentucky 40359-9302, warrants this gas product against defects in materials and workmanship for the earlier of one (1) year from the date the product is shipped by Itron or a period of one year from the date the product is installed by Itron at the original purchaser's site. During such one-year period, provided that the original purchaser continues to own the product, Itron will, at its sole option, repair any defects, replace the product or repay the purchase price.

» This warranty will be void if the purchaser fails to observe the procedures for installation, operation or service of the product as set forth in the Operating Manual and Specifications for the product or if the defect is caused by tampering, physical abuse or misuse of the product.

- » ITRON SPECIFICALLY DISCLAIMS ALL IMPLIED WARRANTIES INCLUDING THOSE OF MERCHANTABILITY OR OF FITNESS FOR A PARTICULAR PURPOSE. UNDER NO CIRCUMSTANCES WILL ITRON BE LIABLE FOR INCIDENTAL OR CONSEQUENTIAL DAMAGES OF ANY KIND WHATSOEVER.
- » Itron's liability for any claim of any kind, including negligence and breach of warranty for the sale and use of any product covered by or furnished, shall in no case exceed the price allocable to the product or part thereof which gives rise to the claim.
- » In the event of a malfunction of the product, consult your Itron Service Representative or Itron Inc., 970 Highway 127 North, Owenton, Kentucky 40359-9302. See Itron Terms and Conditions of Sale for the full and complete terms of the Limited Warranty.

## ORDERING INFORMATION

Specify:

1. Inlet and Outlet Connection Size and Type
2. Model Number
3. Outlet pressure desired
4. Pilot needed
5. Inlet pressure range
6. Type of gas and maximum capacity required
7. Assembly position number (see chart below)
8. Special requirements such as tagging, 1/8" pipe plug tap, seal wire, etc.



At Itron, we're dedicated to delivering end-to-end smart grid and smart distribution solutions to electric, gas and water utilities around the globe. Our company is the world's leading provider of smart metering, data collection and utility software systems, with over 8,000 utilities worldwide relying on our technology to optimize the delivery and use of energy and water.

To realize your smarter energy and water future, start here: [www.itron.com](http://www.itron.com)

## CORPORATE HEADQUARTERS

2111 N Molter Road  
Liberty Lake, WA 99019  
USA

**Phone:** 1.800.635.5461  
**Fax:** 1.509.891.3355